

Модульные сигнальные колонны WERMA серии KombiSIGN 40

Технические характеристики



Архангельск (8182)63-90-72
Астана (7172)727-132
Астрахань (8512)99-46-04
Барнаул (3852)73-04-60
Белгород (4722)40-23-64
Брянск (4832)59-03-52
Владивосток (423)249-28-31
Волгоград (844)278-03-48
Вологда (8172)26-41-59
Воронеж (473)204-51-73
Екатеринбург (343)384-55-89
Иваново (4932)77-34-06

Ижевск (3412)26-03-58
Иркутск (395)279-98-46
Казань (843)206-01-48
Калининград (4012)72-03-81
Калуга (4842)92-23-67
Кемерово (3842)65-04-62
Киров (8332)68-02-04
Краснодар (861)203-40-90
Красноярск (391)204-63-61
Курск (4712)77-13-04
Липецк (4742)52-20-81
Россия (495)268-04-70

Магнитогорск (3519)55-03-13
Москва (495)268-04-70
Мурманск (8152)59-64-93
Набережные Челны (8552)20-53-41
Нижний Новгород (831)429-08-12
Новокузнецк (3843)20-46-81
Новосибирск (383)227-86-73
Омск (3812)21-46-40
Орел (4862)44-53-42
Оренбург (3532)37-68-04
Пенза (8412)22-31-16
Киргизия (996)312-96-26-47

Пермь (342)205-81-47
Ростов-на-Дону (863)308-18-15
Рязань (4912)46-61-64
Самара (846)206-03-16
Санкт-Петербург (812)309-46-40
Саратов (845)249-38-78
Севастополь (8692)22-31-93
Симферополь (3652)67-13-56
Смоленск (4812)29-41-54
Сочи (862)225-72-31
Ставрополь (8652)20-65-13
Казахстан (772)734-952-31

Сургут (3462)77-98-35
Тверь (4822)63-31-35
Томск (3822)98-41-53
Тула (4872)74-02-29
Тюмень (3452)66-21-18
Ульяновск (8422)24-23-59
Уфа (347)229-48-12
Хабаровск (4212)92-98-04
Челябинск (351)202-03-61
Череповец (8202)49-02-64
Ярославль (4852)69-52-93

Единый адрес для всех регионов: wme@nt-rt.ru | | www.werma.nt-rt.ru



KombiSIGN 40 - Modular Signal Tower

Your benefits

There is no need to compromise with the KombiSIGN 40, because WERMA has combined quick installation, excellent visibility and the highest level of flexibility in this product. This saves time and money with regard to installation and order logistics.

- Save up to 50% on installation time thanks to self-explanatory connections and intuitive mechanics
- Maximum flexibility despite a small number of variants
- TwinLIGHT and TwinFLASH combine two easily selectable light effects in one element
- In ClassicLOOK or DesignLOOK to suit all machine surfaces
- Clearly visible from all positions thanks to the OmniVIEW lens with no blind spots
- Pre-configured standard versions are available (common configurations as a complete tower with a single part number)

Typical applications

Fault signalling

- on machinery and equipment
- on automated systems
- in assembly plants, for example, in the automotive industry

Installation options

- Base mounting
- Tube mounting
- Single-hole mounting
- Additional Installation options using accessories

Features

- Multicolour element offers up to seven colours in a single element
- High IP66/69k protection rating prevents ingress of dust and water
- Compact and high-output 95 dB siren
- Optionally available with IO-Link technology
- IP69k allows high pressure washing



Size comparison KombiSIGN 40/72



Signalisation Index			
Optical		Audible	
LED Permanent Light	2	Continuous tone	3
LED Blinking Light	4	Pulse tone	4
LED Flashing Light	5	Multi tone	5
LED EVS Light	5		

How to assemble your KombiSIGN 40 signal tower

► STEP 1
Select the required optical or audible elements.
Order numbers can be found on page 29.

ClassicLOOK



Audible Signal Element

- 8 tone siren
- 2 tone siren

Optical Signal Elements

- TwinLIGHT
- TwinFLASH
- LED Permanent light element multicolour

DesignLOOK



► STEP 2
Select the terminal element and appropriate mounting solution for your application.

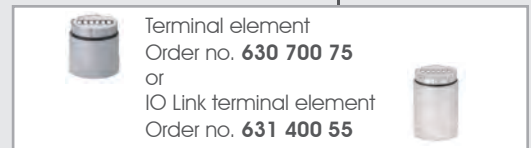
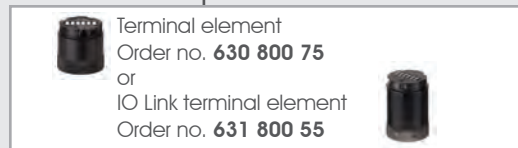

► STEP 3
Optional:
Where appropriate, select the Extension tube. Can be installed between the terminal element and the mounting adapter.

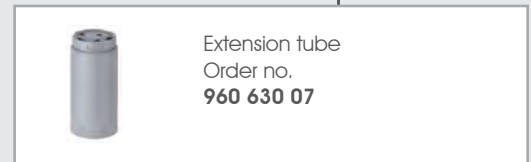
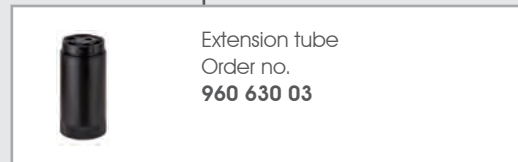

► STEP 4
Select mounting adapter as required.



► STEP 5
Where appropriate, select the bracket.



Further accessories can be found in our main catalogue





KombiSIGN 40 - Modular Signal Tower

Or use one of our pre-configured signal towers. With just one part number you can obtain the most popular configurations.



KombiSIGN 40 Signal Tower
in ClassicLOOK und DesignLOOK

TECHNICAL SPECIFICATIONS/ORDER SPECIFICATIONS:

Pre-configured signal tower	ClassicLOOK	DesignLOOK
Dimensions (Ø x Height):	40 mm x 214 mm	
Voltage:	24 V AC/DC	
TwinLIGHT green/yellow/red	639 300 01	639 301 01
Consisting of:		
	 634 110 75 + 634 310 75 + 634 210 75 + 630 800 75 + 630 810 00	 634 130 75 + 634 330 75 + 634 230 75 + 630 700 75 + 630 710 00

Technical details are given on the relevant product page.

ACCESSORIES

	ClassicLOOK	DesignLOOK
Bracket for concealed cable entry	960 630 01	960 630 05

TECHNICAL DIAGRAMS:

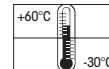
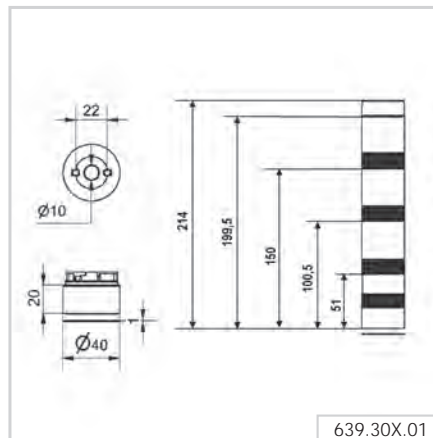

KombiSIGN 40 - Optical Signal Elements



KombiSIGN 40 Signal Tower
in ClassicLOOK and DesignLOOK

TECHNICAL SPECIFICATIONS/ORDER SPECIFICATIONS:

	ClassicLOOK	DesignLOOK
Dimensions (Ø x Height):	40 mm x 59 mm	
Lens:	PC, transparent	
Life duration:	50,000 hrs	
TwinLIGHT		
Light effects:	LED Permanent or Blinking light, adjustable via slide switch	
Voltage:	24 V AC/DC	
Current consumption:	< 30 mA	
red	634 110 75	634 130 75
green	634 210 75	634 230 75
yellow	634 310 75	634 330 75
white	634 430 75	634 430 75
blue	634 510 75	634 530 75
TwinFLASH		
Light effect:	LED Flash light or EVS, adjustable via DIP-Switch	
Voltage:	24 V DC	
Current consumption:	< 65 mA	
red	634 120 55	634 140 55
green	634 220 55	634 240 55
yellow	634 320 55	634 340 55
white	634 440 55	634 440 55
blue	634 520 55	634 540 55
Multicolour		
Light effect:	LED Permanent light	
Colours:	Red, yellow, green, blue, white, violet, turquoise controlled by binary inputs	
Voltage:	24 V DC	
Current consumption:	< 60 mA	
Order No.:	634 450 55	634 450 55

TECHNICAL DIAGRAMS:

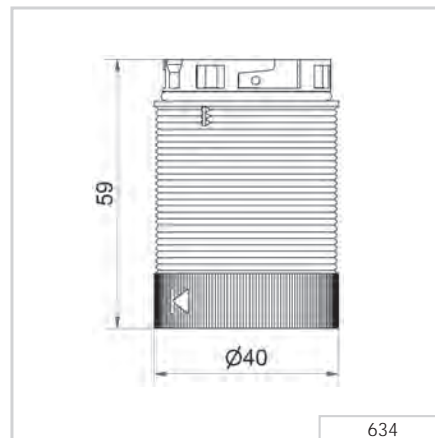

Class 2

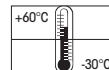



KombiSIGN 40 - Audible Signal Elements



8 tone KombiSIGN 40 siren
in DesignLOOK



2 tone KombiSIGN 40 siren
in ClassicLOOK

TECHNICAL SPECIFICATIONS/ORDER SPECIFICATIONS:

	ClassicLOOK	DesignLOOK
Housing:		PC
Life duration:		5,000 hrs
2 Tone Siren		
Dimensions (Ø x Height):	40 mm x 45 mm	
Sound output:	85 dB (A)	
Tone type:	Continuous or pulse tone, can be set via slide switch	
Voltage:	24 V AC/DC	
Current consumption:	< 80 mA	
Order No.	635 800 75	635 700 75
8 Tone Siren		
Dimensions (Ø x Height):	40 mm x 68 mm	
Sound output:	89-95 dB (A), can be set via slide switch	
Tone type:	8 tones, can be set via slide switch	
Voltage:	24 V AC/DC	
Current consumption:	< 200 mA	
Order No.	635 810 75	635 710 75

TECHNICAL DIAGRAMS:

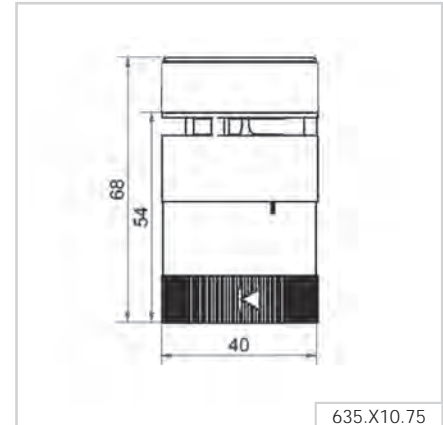
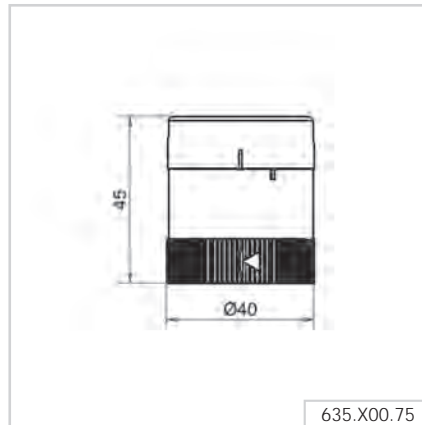

Class 2



635 X00 75



635 X10 75



635 X00 75



635 X10 75

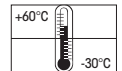

KombiSIGN 40 - Terminal Elements



KombiSIGN 40 DesignLOOK assembly adapter for single hole mounting



KombiSIGN 40 ClassicLOOK assembly adapter for base mounting



KombiSIGN 40 DesignLOOK assembly adapter for tube mounting

TECHNICAL SPECIFICATIONS/ORDER SPECIFICATIONS:

	ClassicLOOK	DesignLOOK
Housing:	PC	
Terminal element		
Dimensions (Ø x Height):	40 mm x 40 mm	
Cable entry:	Cable diameter max. 9 mm	
Connection:	Push-in terminal max. 1.5 mm ²	
Number of tiers possible:	Max. 5	
Voltage:	24 V AC/DC	
Order No.	630 800 75	630 700 75
IO Link Terminal element		
Dimensions (Ø x Height):	40 mm x 59 mm	
Cable entry:	Cable diameter max. 9 mm	
Connection:	Push-in terminal max. 0.75 mm ²	
Number of tiers possible:	Max. 5	
Voltage:	24 V via IO-Link	
Current consumption:	10 mA	
Order No.	631 800 55	631 400 55
Adapter for base mounting		
Dimensions (Ø x Height):	40 mm x 30 mm	
Order No.	630 810 00	630 710 00
Adapter single hole mounting		
Dimensions (Ø x Height):	40 mm x 54 mm	
Order No.	630 820 00	630 720 00
Adapter tube mounting		
Dimensions (Ø x Height):	40 mm x 75 mm	
Order No.	630 830 00	630 730 00

ACCESSORIES: SEE PAGE 27

TECHNICAL DIAGRAMS:

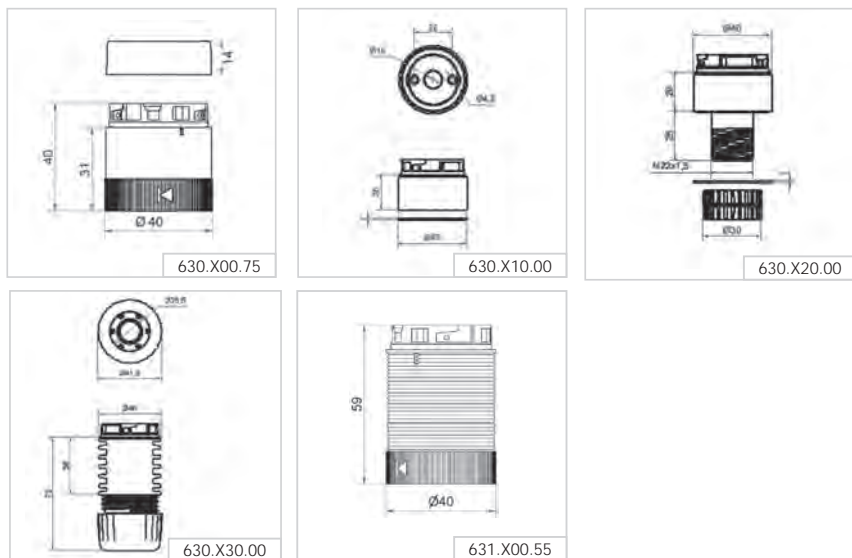

Class 2



630 X00 75



630 X10 00



630 X20 00



630 X30 00

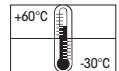
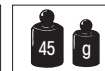

Архангельск (8182)63-90-72	Ижевск (3412)26-03-58	Магнитогорск (3519)55-03-13	Пермь (342)205-81-47	Сургут (3462)77-98-35
Астана (7172)727-132	Иркутск (395)279-98-46	Москва (495)268-04-70	Ростов-на-Дону (863)308-18-15	Тверь (4822)63-31-35
Астрахань (8512)99-46-04	Казань (843)206-01-48	Мурманск (8152)59-64-93	Рязань (4912)46-61-64	Томск (3822)98-41-53
Барнаул (3852)73-04-60	Калининград (4012)72-03-81	Набережные Челны (8552)20-53-41	Самара (846)206-03-16	Тула (4872)74-02-29
Белгород (4722)40-23-64	Калуга (4842)92-23-67	Нижний Новгород (831)429-08-12	Санкт-Петербург (812)309-46-40	Тюмень (3452)66-21-18
Брянск (4832)59-03-52	Кемерово (3842)65-04-62	Новокузнецк (3843)20-46-81	Саратов (845)249-38-78	Ульяновск (8422)24-23-59
Владивосток (423)249-28-31	Киров (8332)68-02-04	Новосибирск (383)227-86-73	Севастополь (8692)22-31-93	Уфа (347)229-48-12
Волгоград (844)278-03-48	Краснодар (861)203-40-90	Омск (3812)21-46-40	Симферополь (3652)67-13-56	Хабаровск (4212)92-98-04
Вологда (8172)26-41-59	Красноярск (391)204-63-61	Орел (4862)44-53-42	Смоленск (4812)29-41-54	Челябинск (351)202-03-61
Воронеж (473)204-51-73	Курск (4712)77-13-04	Оренбург (3532)37-68-04	Сочи (862)225-72-31	Череповец (8202)49-02-64
Екатеринбург (343)384-55-89	Липецк (4742)52-20-81	Пенза (8412)22-31-16	Ставрополь (8652)20-65-13	Ярославль (4852)69-52-93
Иваново (4932)77-34-06	Россия (495)268-04-70	Киргизия (996)312-96-26-47	Казахстан (772)734-952-31	

Единый адрес для всех регионов: wme@nt-rt.ru | www.wema.nt-rt.ru