

Модульные сигнальные колонны WERMA серии KombiSIGN 72

Технические характеристики



Архангельск (8182)63-90-72
 Астана (7172)727-132
 Астрахань (8512)99-46-04
 Барнаул (3852)73-04-60
 Белгород (4722)40-23-64
 Брянск (4832)59-03-52
 Владивосток (423)249-28-31
 Волгоград (844)278-03-48
 Вологда (8172)26-41-59
 Воронеж (473)204-51-73
 Екатеринбург (343)384-55-89
 Иваново (4932)77-34-06

Ижевск (3412)26-03-58
 Иркутск (395)279-98-46
 Казань (843)206-01-48
 Калининград (4012)72-03-81
 Калуга (4842)92-23-67
 Кемерово (3842)65-04-62
 Киров (8332)68-02-04
 Краснодар (861)203-40-90
 Красноярск (391)204-63-61
 Курск (4712)77-13-04
 Липецк (4742)52-20-81
 Россия (495)268-04-70

Магнитогорск (3519)55-03-13
 Москва (495)268-04-70
 Мурманск (8152)59-64-93
 Набережные Челны (8552)20-53-41
 Нижний Новгород (831)429-08-12
 Новокузнецк (3843)20-46-81
 Новосибирск (383)227-86-73
 Омск (3812)21-46-40
 Орел (4862)44-53-42
 Оренбург (3532)37-68-04
 Пенза (8412)22-31-16
 Киргизия (996)312-96-26-47

Пермь (342)205-81-47
 Ростов-на-Дону (863)308-18-15
 Рязань (4912)46-61-64
 Самара (846)206-03-16
 Санкт-Петербург (812)309-46-40
 Саратов (845)249-38-78
 Севастополь (8692)22-31-93
 Симферополь (3652)67-13-56
 Смоленск (4812)29-41-54
 Сочи (862)225-72-31
 Ставрополь (8652)20-65-13
 Казахстан (772)734-952-31

Сургут (3462)77-98-35
 Тверь (4822)63-31-35
 Томск (3822)98-41-53
 Тула (4872)74-02-29
 Тюмень (3452)66-21-18
 Ульяновск (8422)24-23-59
 Уфа (347)229-48-12
 Хабаровск (4212)92-98-04
 Челябинск (351)202-03-61
 Череповец (8202)49-02-64
 Ярославль (4852)69-52-93

Единый адрес для всех регионов: wme@nt-rt.ru | | www.werma.nt-rt.ru



KombiSIGN 72 - Signal Tower

Your benefits

There is no need to compromise with the KombiSIGN 72, because this product combines quick installation, excellent visibility and the highest level of flexibility. This saves time and money with regard to installation and order logistics.

- Smooth surfaces prevent dirt gathering and make cleaning easy
- Easy, intuitive installation - incorrect assembly is practically impossible (Poka Yoke)
- High-tech: the Signal Towers can easily be retrofitted with SmartMONITOR (smart MDC alternative) or AndonSPEED (call-for-action system)
- TwinLIGHT and TwinFLASH combine two easily selectable light effects in one element
- In ClassicLOOK or DesignLOOK to suit all machine surfaces
- Clearly visible from all positions thanks to the OmniVIEW lens with no blind spots
- Pre-configured standard versions are available (common configurations as a complete tower with a single part number)

Typical applications

The new definition of the industry standard to signal faults

- on machinery and equipment
- on automated systems
- in assembly plants, for example, in the automotive industry
- on conveyor belts in production and logistics
- at manual workstations as a call-for-action system
- upgradeable to the wireless-based MDC alternative SmartMONITOR or to the call-for-action system AndonSPEED in logistics applications

Installation options

- Base mounting
- Tube mounting
- Additional installation options using accessories

Features

- Combine the KombiSIGN 72 light elements with special controller solutions such as USB or ASi, or integrate one of the versatile audible elements
- Can be combined and retrofitted with all the KombiSIGN 71 elements and accessories, as well as the SmartMONITOR and AndonSPEED wireless-based systems
- High-output 105 dB siren

TwinLIGHT
TwinFLASH



Size comparison KombiSIGN 72 / 40



Signalisation Index

Optical		Audible	105 dB Siren
LED Permanent Light	4	Continuous tone	5
LED Blinking Light	5	Pulse tone	6
LED Flashing Light	6		
LED EVS	6		

How to assemble your KombiSIGN 72 signal tower

ClassicLOOK

► STEP 1
Select the required optical or audible elements in the correct voltage (for details see page 35).



Audible Signal Element
 • 2 tone siren
 Optical Signal Elements
 • TwinLIGHT
 • TwinFLASH
 IO Link terminal element

DesignLOOK



► STEP 2
Select the appropriate mounting option for your application.

► STEP 3
Select the correct terminal element for your mounting option (for details see page 37).

► STEP 4
Where appropriate, select a base and the desired tube length (only for tube mounting) (For details see page 64).

► STEP 5
Where appropriate, select the bracket and the contact box (for details see page 64).

ClassicLOOK		DesignLOOK	
Base Mounting	Tube Mounting	Base Mounting	Tube Mounting
 Terminal element with CAGE CLAMP® technology Order no. 640 800 00	 Terminal element with CAGE CLAMP® technology Order no. 640 810 00	 Terminal element with CAGE CLAMP® technology Order no. 640 900 00	 Terminal element with CAGE CLAMP® technology Order no. 640 910 00
 Base with integrated tube Order no. 975 840 10	Tube Ø 25 mm, all anodised Order no. 100 mm long 975 845 10 250 mm long 975 840 25 400 mm long 975 840 40 600 mm long 975 840 60 800 mm long 975 840 80 1000 mm long 975 840 03 Base for Tube, plastic Order no. 975 840 90 Base for Tube, metal Order no. 975 840 91	 Base with integrated tube Order no. 960 000 51	Tube Ø 25 mm, all anodised Order no. 100 mm long 975 845 10 250 mm long 975 840 25 400 mm long 975 840 40 600 mm long 975 840 60 800 mm long 975 840 80 1000 mm long 975 840 03 Base for Tube, plastic Order no. 960 000 50
 Bracket for base mounting Order no. 960 000 02 Bracket for 1-sided mounting Order no. 975 840 85 Bracket for 2-sided mounting Order no. 975 840 86	 Bracket for base mounting with concealed cable entry Order no. 960 000 14 Bracket for tube mounting Order no. 960 000 01	 Bracket for base mounting Order no. 960 000 53 Bracket for 1-sided mounting Order no. 960 000 52	 Bracket for base mounting with concealed cable entry Order no. 960 000 55 Bracket for tube mounting Order no. 960 000 54
Further accessories can be found in our main catalogue			

With the new signal tower configurator you can put together your own individual signal tower.









KombiSIGN 72 - Modular Signal Tower

Or use one of our pre-configured signal towers. With just one part number you can obtain the most popular configurations.



① TECHNICAL SPECIFICATIONS/ORDER SPECIFICATIONS:

Pre-configured signal tower	ClassicLOOK	DesignLOOK
Dimensions (Ø x Height):	70 mm x 211.5 mm	
Voltage:	24 V AC/DC	
Base/Bracket mounting		
Consisting of:		
	 647 110 75 + 647 310 75 + 647 210 75 + 640 800 00	 647 130 75 + 647 330 75 + 647 230 75 + 640 900 00
TwinLIGHT green/yellow/red	649 000 01	649 001 01
Tube mounting		
Dimensions (Ø x Height):	70 mm x 299 mm	
Consisting of:		
	 647 110 75 + 647 310 75 + 647 210 75 + 640 810 00 + 975 840 10	 647 130 75 + 647 330 75 + 647 230 75 + 640 910 00 + 960 000 51
TwinLIGHT green/yellow/red	649 000 02	649 001 02

Technical details are given on the relevant product page.

✂ ACCESSORIES:

	ClassicLOOK	DesignLOOK
Bracket for 1-sided mounting	975 840 85	960 000 52
Bracket for base mounting	960 000 02	960 000 53
Bracket for tube mounting	960 000 01	960 000 54

↔ TECHNICAL DIAGRAMS:

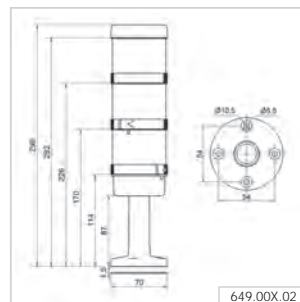
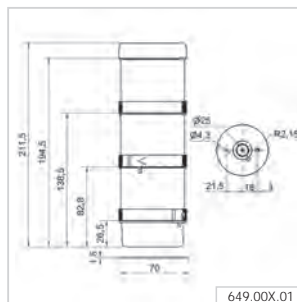

649 00X 01

649 00X 02

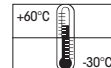

KombiSIGN 72 - Optical Signal Elements



TECHNICAL SPECIFICATIONS/ORDER SPECIFICATIONS:

	ClassicLOOK	DesignLOOK
Dimensions (Ø x Height):	70 mm x 65.5 mm	
Lens:	PC, transparent	
TwinLIGHT		
Light effects:	LED Permanent light, LED Blinking light, adjustable via slide switch	
Voltage:	24 V AC/DC	
Current consumption:	< 80 mA	
red	647 110 75	647 130 75
green	647 210 75	647 230 75
yellow	647 310 75	647 330 75
white	647 430 75	647 430 75
blue	647 510 75	647 530 75
TwinFLASH		
Light effect:	LED Flashing light, LED EVS light, adjustable via slide switch	
Voltage:	24 V DC	
Current consumption:	< 80 mA	
red	647 120 55	647 140 55
green	647 220 55	647 240 55
yellow	647 320 55	647 340 55
white	647 440 55	647 440 55
blue	647 520 55	647 540 55

TECHNICAL DIAGRAMS:

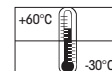
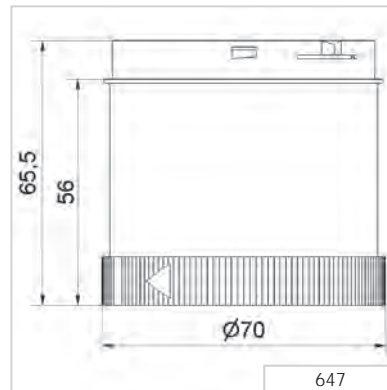



KombiSIGN 72 - Audible Signal Elements



2 and 8 tone siren
KombiSIGN 72
DesignLOOK

TECHNICAL SPECIFICATIONS/ORDER SPECIFICATIONS:

	ClassicLOOK	DesignLOOK
Housing:	PC	
Life duration:	5,000 hrs	
2 Tone Siren		
Dimensions (Ø x Height):	70 mm x 54 mm	
Sound output:	95-105 dB (A), adjustable by slide switch	
Tone type:	Permanent tone or alternating tone, selectable by slide switch	
Voltage:	24 V AC/DC	
Current consumption:	< 40 mA	
Order no.	645 870 75	645 770 75
8 Tone Siren		
Dimensions (Ø x Height):	70 mm x 54 mm	
Sound output::	95-105 dB (A), adjustable by slide switch	
Tone type:	8 tones, can be set via slide switch	
Voltage:	24 V AC/DC	
Current consumption:	< 30 mA	
Order no.	645 890 75	645 790 75
Voltage:	115-230 V AC	
Current consumption:	< 45 mA	
Order no.	645 890 60	645 790 60

TECHNICAL DIAGRAMS:

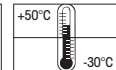
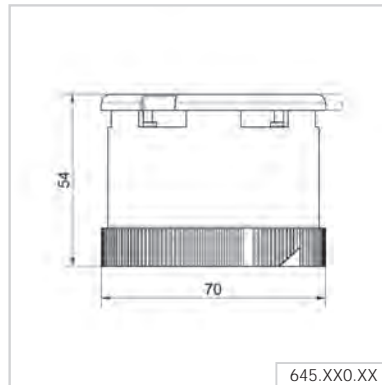

KombiSIGN 72 - Terminal Elements



Terminal element
KombiSIGN 72
DesignLOOK



Terminal element
KombiSIGN 72
ClassicLOOK



IO Link element
KombiSIGN 72
ClassicLOOK



IO Link element
KombiSIGN 72
DesignLOOK

TECHNICAL SPECIFICATIONS/ORDER SPECIFICATIONS:

	ClassicLOOK	DesignLOOK
Dimensions (Ø x Height):	70 mm x 36 mm	
Housing:	Terminal element: PA-GF Cap: PC	
Fixing:	Base mounting, Tube mounting for tube Ø 25 mm (accessory), Bracket mounting (accessory)	
Cable entry:	Cable diameter max. 11 mm	
Connection:	CAGE CLAMP® technology max. 1.5 mm ²	
Protection rating:	IP 65	
Number of tiers possible:	Max. 5	
Voltage:	12-230 V AC/DC	
Base mounting	640 800 00	640 900 00
Tube mounting	640 810 00	640 910 00
IO Link element		
Dimensions (Ø x Height):	70 mm x 65.5 mm	
Numbers of tiers possible:	Max. 5	
Voltage:	24 V via IO-Link	
Current consumption:	6 mA	
Order no.	646 840 55	646 440 55

ACCESSORIES:

	ClassicLOOK	DesignLOOK
Base with integrated tube	975 840 10	960 000 51
Bracket for 1-sided mounting	975 840 85	960 000 52
Bracket for base mounting	960 000 02	960 000 53
Bracket for tube mounting	960 000 01	960 000 54
Bracket for base mounting with concealed cable entry	960 000 14	960 000 55
Base for tube Ø 25 mm, plastic	975 840 90	960 000 50

Additional accessories can be found on page 64.

TECHNICAL DIAGRAMS:

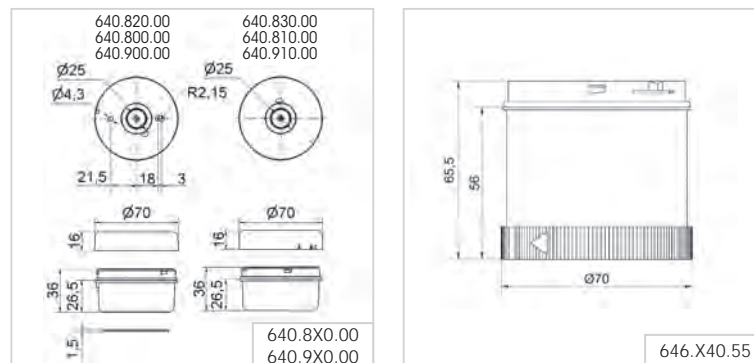

646.440.55
Class 2



Max.

646.440.55
646.840.55

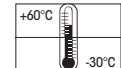
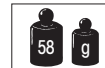
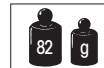

Архангельск (8182)63-90-72	Ижевск (3412)26-03-58	Магнитогорск (3519)55-03-13	Пермь (342)205-81-47	Сургут (3462)77-98-35
Астана (7172)727-132	Иркутск (395)279-98-46	Москва (495)268-04-70	Ростов-на-Дону (863)308-18-15	Тверь (4822)63-31-35
Астрахань (8512)99-46-04	Казань (843)206-01-48	Мурманск (8152)59-64-93	Рязань (4912)46-61-64	Томск (3822)98-41-53
Барнаул (3852)73-04-60	Калининград (4012)72-03-81	Набережные Челны (8552)20-53-41	Самара (846)206-03-16	Тула (4872)74-02-29
Белгород (4722)40-23-64	Калуга (4842)92-23-67	Нижний Новгород (831)429-08-12	Санкт-Петербург (812)309-46-40	Тюмень (3452)66-21-18
Брянск (4832)59-03-52	Кемерово (3842)65-04-62	Новокузнецк (3843)20-46-81	Саратов (845)249-38-78	Ульяновск (8422)24-23-59
Владивосток (423)249-28-31	Киров (8332)68-02-04	Новосибирск (383)227-86-73	Севастополь (8692)22-31-93	Уфа (347)229-48-12
Волгоград (844)278-03-48	Краснодар (861)203-40-90	Омск (3812)21-46-40	Симферополь (3652)67-13-56	Хабаровск (4212)92-98-04
Вологда (8172)26-41-59	Красноярск (391)204-63-61	Орел (4862)44-53-42	Смоленск (4812)29-41-54	Челябинск (351)202-03-61
Воронеж (473)204-51-73	Курск (4712)77-13-04	Оренбург (3532)37-68-04	Сочи (862)225-72-31	Череповец (8202)49-02-64
Екатеринбург (343)384-55-89	Липецк (4742)52-20-81	Пенза (8412)22-31-16	Ставрополь (8652)20-65-13	Ярославль (4852)69-52-93
Иваново (4932)77-34-06	Россия (495)268-04-70	Киргизия (996)312-96-26-47	Казахстан (772)734-952-31	

Единый адрес для всех регионов: wme@nt-rt.ru | www.wema.nt-rt.ru